

Shorter trawls improve size selection of northern shrimp

Ólafur Arnar Ingólfsson and Terje Jørgensen

Abstract: Discards of small northern shrimp (*Pandalus borealis*) are a problem in the Skagerrak northern shrimp trawl fishery. To reduce catches of small shrimp, we studied the effect of trawl belly length on size selectivity in November 2017 and June 2018 onboard 15 and 27 m double-rigged shrimp trawlers. The selectivity of the vessels' standard trawl was compared with a trawl differing only in the belly length, being 37% shorter. The trawls had 40 mm bottom panels and cod ends of 35 mm mesh sizes. Eleven and 14 hauls were made, respectively, in 2017 aboard the 15 m vessel and in 2018 aboard the 27 m vessel. The trawls fished shrimp above 19 mm carapace length equally, while catch rates of shrimp below 15.5–16 mm carapace length in the shorter trawl were more than halved. The results were consistent between the two vessels. In short, modifying trawl length is a simple design modification that can reduce catches of small shrimp. Bycatch of Norway pout (*Trisopterus esmarkii*) was slightly reduced in the shorter trawl, unrelated to fish length.

Résumé : Les rejets de petites crevettes nordiques (*Pandalus borealis*) constituent un problème dans la pêche à la crevette nordique au chalut du Skagerrak. Dans le but de réduire les prises de petites crevettes, nous avons étudié l'effet de la longueur du ventre du chalut sur la sélectivité selon la taille en novembre 2017 et juin 2018 à bord de crevetters à deux chaluts de 15 et 27 m. La sélectivité du chalut standard des navires a été comparée à celle d'un chalut dont la seule différence était son ventre de 37 % plus court. Le maillage des panneaux inférieurs était de 40 mm et celui des culs, de 35 mm. Onze et quatorze traits ont été effectués, respectivement, en 2017 par le navire de 15 m et en 2018 par le navire de 27 m. Les prises de crevettes de longueur de carapace de plus de 19 mm étaient égales pour les deux chaluts, alors que les taux de prises de crevettes de moins de 15,5–16 mm de longueur de carapace étaient au moins deux fois moindres pour le chalut court que pour le chalut standard. Les résultats des deux navires concordait. En résumé, changer la longueur du chalut est une modification simple de la conception qui peut réduire les prises de petites crevettes. Les prises accessoires de tacauds norvégiens (*Trisopterus esmarkii*) étaient légèrement moindres dans le chalut plus court, sans relation avec la longueur des poissons. [Traduit par la Rédaction]

Introduction

A large proportion of global fish discards has been attributed to small-mesh trawl fisheries, including shrimp trawling (Kelleher 2005). This was largely remedied in the North Atlantic northern shrimp (*Pandalus borealis*) fisheries by the introduction of the Nordmøre sorting grid designs (Isaksen et al. 1992; Madsen and Hansen 2001), which are now in use in most northern shrimp fisheries (Halliday and Cooper 1999; Garcia 2007; Aldrin et al. 2012; Gullestad et al. 2015). The grids are recognised as a successful selection device, resulting in cleaner catches, and are greatly appreciated by both fishers and fishery managers. However, shrimp, juvenile fish, and individuals of small species are only to a small extent excluded by the grid, and their chances of escaping generally depend on cod-end mesh selection. (Isaksen et al. 1992; Garcia 2007; Aldrin et al. 2012).

Annual catches from the *Pandalus* fishery in the Skagerrak and Norwegian Deep have ranged between 8000 and 16 000 tonnes (t) for the last 30 years. Shrimp in the area are managed as a single stock, with the total allowable catch (TAC) shared by Norway (59%), Sweden (14%), and Denmark (27%). In 2017, six Danish, 40 Swedish, and 214 Norwegian vessels participated in the fishery (NAFO SCS Doc. 18/21 Serial No. N6898; www.nafo.int). The three national fleets use similar trawl gear (Eigaard and Munch-Petersen 2011) with minimum legal mesh sizes of 35 mm. Sorting grids have been mandatory since 2013 in the Skagerrak and since 2015 in the North Sea south of 62°N, except in Norwegian coastal waters within

four nautical miles (1 n.m. = 1.852 km) of the baseline. The technical regulations include bycatch limitations and landing obligations that include juvenile shrimp. Norwegian and Swedish fishers boil most large shrimp (≥ 20 mm carapace length (CL)) on board. Boiled shrimp sell for a much higher price (five to six times) than the raw shrimp that go to processing. This has resulted in incentives for high-grading of catches, particularly for vessels with small quotas. World Wildlife Fund (WWF) in Norway and Sweden red-listed the Skagerrak northern shrimp fishery in 2014 (WWF's Seafood Guide 2014; http://awsassets.wwf.no/downloads/sjomatguide_2014_web.pdf). The red-listing is an attempt to save species from being overfished, and many supermarket chains now boycott red-listed species. Particular concerns were the discarding of juvenile shrimp and catches of specimens of vulnerable species, mainly cod (*Gadus morhua*) for which the permitted bycatch quota is very low. A concerted action in both countries has attempted to develop technical solutions to the juvenile shrimp bycatch problem. The technical revised regulations concerning the shrimp fishery in Norwegian waters also include a rise in the minimum legal size of shrimp from 6 to 7 cm (though this was later reduced to 6.5 cm) and the option of imposing real-time closures in areas in which undersized shrimp make up 15% or more by number of the catch (Anonymous 2005).

Most studies of technical measures to reduce or avoid catches of small shrimp have focused on cod-end mesh selection and rigid size-sorting grids. For most species, selection is believed to take place in the cod end (Wileman et al. 1996). Cod-end mesh size is thus generally regulated, and in the Northeast Atlantic northern

Received 15 November 2018. Accepted 1 July 2019.

Ó.A. Ingólfsson and T. Jørgensen. Institute of Marine Research, Fish Capture Research Group, P.O. Box 1879 Nordnes, NO-5817 Bergen, Norway.

Corresponding author: Ólafur Arnar Ingólfsson (email: olafur.arnar.ingolfsson@hi.no).

Copyright remains with the author(s) or their institution(s). This work is licensed under a [Creative Commons Attribution 4.0 International License](https://creativecommons.org/licenses/by/4.0/) (CC BY 4.0), which permits unrestricted use, distribution, and reproduction in any medium, provided the original author(s) and source are credited.

shrimp fisheries, mesh size is usually 35–44 mm (Garcia 2007). The reported selection factors (SF = L50/mesh size, L50 = length at 50% retention) for northern shrimp, using diamond-mesh cod ends, range from about 0.3 (Christensen and Lassen 1990; Lehmann et al. 1993) to 0.4 (Thomassen and Ulltang 1975; Degel et al. 1991; Valdemarsen and Mikalsen 1991). The difference has been suggested to be related to trawl dimensions and catch size (Degel et al. 1991; Valdemarsen and Mikalsen 1991; Lehmann et al. 1993). In addition, the circumference of the cod end is known to affect size selectivity (Reeves et al. 1992; Graham et al. 2009; Sala and Lucchetti 2011), also for northern shrimp (Ó.A. Ingólfsson and T. Jørgensen, Institute of Marine Research, Bergen, Norway, manuscript in preparation, 2019).

Square-mesh cod ends have been shown to be more efficient than diamond meshes in reducing catches of small shrimp (Thorsteinsson 1992; Broadhurst et al. 2006). However, one study in an offshore fishery did not reduce catches of small shrimp with square-mesh cod ends (Lehmann et al. 1993). While square-mesh cod ends have been adopted in some shrimp fisheries, Hickey et al. (1993) reported problems when emptying medium to large catches from such cod ends, due to the lateral inflexibility of the square meshes. Rigid size-sorting grids have been tested in northern shrimp fisheries, using grid frames in the bottom panel (Valdemarsen et al. 1993; He and Balzano 2012) ahead of a Nordmøre grid (Isaksen et al. 1992). He and Balzano (2012) achieved significant size selection for northern shrimp in inshore fisheries in 1 h hauls that made catches of up to 107 kg·h⁻¹ per cod end, using a grid mounted in front of the Nordmøre grid. However, the relative selection ogive was shallow, resulting in ~50% catch losses at 13 mm and a significant reduction of shrimp of sizes up to 23 mm CL. The benefits of using grids rather than increasing mesh size has been questioned unless sharper size selection can be achieved (Valdemarsen et al. 1993).

It has been shown that the trawl body influences the size composition of decapod catches. A selectivity study of a shrimp beam trawl showed that more brown shrimp (*Crangon crangon*) escape through the trawl body than through the cod end (Polet 2000). Similarly, Hillis and Earley (1982) demonstrated that the selectivity of the trawl body was far more important than the cod end in the Irish trawl fisheries for *Nephrops norvegicus*. Recent studies on trawl design in the Australian school prawn (*Metapenaeus macleayi*) fishery found size-selective effects of mesh sizes, belly length, and square-mesh configurations in the wings and side panels (Broadhurst et al. 2012, 2014). Small northern shrimp have been observed escaping in large numbers through the side panels of a trawl in the Icelandic trawl fisheries (Thorsteinsson 1981).

Gaps in our current knowledge of selectivity over a wide range of trawl designs, cod-end dimensions, catch sizes, etc., complicate the choice of “best” size-selective devices. All the aforementioned technical measures improve the overall selective properties of the gear. However, it can be argued that by following the principle of parsimony and choosing the simplest solution, the core components of the trawl, i.e., trawl belly and cod end, should be designed to limit unwanted catches before additional devices such as grids are employed. Restricting the dimensions of the cod end and designing it to improve size selection would seem to be a natural choice. Moreover, differences already observed in performance between various trawl designs raise the question of whether the trawl itself, i.e., the trawl belly, could be designed to better select shrimp before they encounter grids and cod ends in the aft part of the trawl.

In this study, we test a modification of a trawl design used by many Norwegian shrimp trawlers in the Skagerrak, where the conventional trawl belly is replaced with a shorter one, whose panels have steeper cutting profiles. The objective is to investigate if the steeper cutting and assumed greater angle of attack for shrimp contacting the netting improves size selection.

Materials and methods

Two comparative sea trials with standard and shortened-belly shrimp trawls were conducted in the Skagerrak on board commercial shrimp trawlers rigged for double trawling. Trial 1 lasted from 9 to 15 November 2017 with the vessel *Tempo*, 27.4 m length overall, with a 745 kW main engine. Trial 2 was conducted from 23 June to 6 July 2018 with the 14.95 m length overall and 335 kW *Silje Kristina*. Each vessel's conventional commercial trawl (Figs. 1 and 2) was towed on one side as a control and a shorter but otherwise identical experimental trawl (Figs. 3 and 4) on the other side. On the *Tempo*, the shorter trawl was fished on the port side throughout the experiment. On the *Silje Kristina*, the shorter trawl was on the port side for the first seven hauls, before sides were interchanged.

The experimental trawls in each study were identical from the fishing circle and forward, i.e., overhang (square), wings, ground gear, headline, and bridles. The nets were manufactured by the net-loft Skagerak trål og notbøteri AS. All trawls were fished with identical Nordmøre grids with 19 mm bar spacing and cod ends of 35 mm nominal mesh size. The fishing circles of *Tempo*'s trawls had a stretched circumference of 174 m. The cod ends used were new, 16 m long, and 500 meshes in circumference. The trawls were fished with a pair of 2500 kg, 16 m² Thyborøn trawl doors, a 3000 kg centre weight, and 53 m-long bridles. The stretched circumference of the trawls used on *Silje Kristina* was 102 m. The cod ends used were 12 m long and 400 meshes in circumference, used but in good condition. The trawls were fished with a pair of 700 kg, 3.4 m² Thyborøn trawl doors, a 1000 kg centre weight, and 35 m-long bridles.

The “steepness” of the funnel-shaped trawl belly is determined by the cutting of the panels that form it. The cutting is a combination of Ns (nominal, in the netting longitudinal direction) and Bs (bars). Since 2B = 1N and 1T (transversal), a cutting of xN-yB means that the netting is cut y/2 meshes transversal for every x + y/2 in the longitudinal direction.

On the *Tempo*, the control trawl had a 60 m-long trawl belly (netting cone from centre of fishing line to start of grid section), with bottom and top panels cut 1N-4B at the foremost section, gradually shifting to shallower cuts, 6N-2B at the rearmost section. The first 20 m of the side panels were untapered, then the next 36 m were cut 2N-2B. The short experimental trawl had a 37.6 m-long trawl belly. The first 27.6 m of the bottom and top panels were cut 1N-8B, and the rearmost 10 m were cut 1N-2B for smoother connection to the N-cut grid section and cod end. The side panels were cut 3N-2B. The funnel-shaped bellies were thus reduced in circumference by 2.2 and 3.4 meshes on average, for every mesh in the trawl's longitudinal direction, for the control and test trawls, respectively. The slope of the bottom panel of the belly was calculated at 14 degrees for the short, experimental trawl and 8 degrees for the standard, control trawl (Fig. 5).

On the *Silje Kristina*, the control trawl (Fig. 4) had a 36 m-long trawl belly, with bottom and top panels cut 1N-4B at the foremost section, gradually shifting to shallower cuts, 3N-4B at the rearmost section. The side panels were tapered and cut 3N-2B. The shorter experimental trawl (Fig. 2) had a 22.5 m-long trawl belly. The first 16.5 m of the bottom and top panels were cut 1N-8B, and the rearmost 6 m were cut 1N-2B. The funnel-shaped bellies were therefore reduced in circumference by 2.4 and 3.8 meshes on average, for every mesh in the trawl's longitudinal direction, for the control and test trawls, respectively. The resulting slopes of the bottom panels were identical to those on the *Tempo*.

The shrimp catches from the two cod ends were kept separately and weighed to the nearest kilogram. Samples of 1.5 to 4 kg of shrimp for length measurements were taken from each cod-end catch, aiming for sample sizes of >400 specimens. Shrimp CLs were measured with a digital caliper with an accuracy of 0.01 mm, and all numbers were rounded to the nearest 0.5 mm.

Fig. 1. The conventional trawl of *Tempo* used in trial 1.

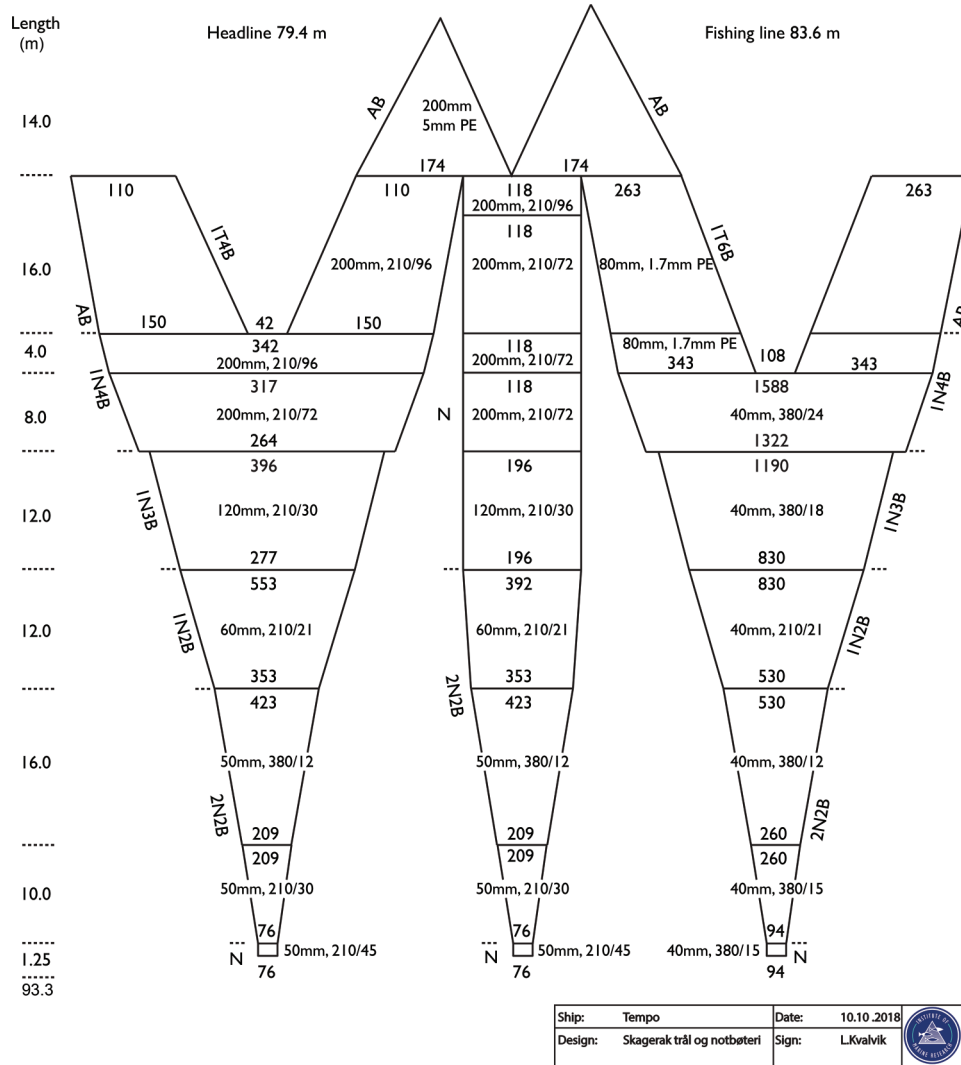

Aboard the *Tempo*, bycatch measurements were not possible for logistic reasons. However, aboard the *Silje Kristina*, the entire bycatch was identified to species and measured. To conduct the experiment in line with commercial practice for the Norwegian shrimp trawlers in Skagerrak and the North Sea, we mounted a 125 mm square-mesh collecting bag to the fish outlet of the grid. The collecting bag was attached lengthwise to the top of the cod end. *Tempo* used a separate fish cod end, while *Silje Kristina* used a configuration where the rear end of the collecting bag opened into the cod end. The fish that do not pass through the grid are thus first led into a large-mesh funnel for size selection, before they are flushed into the main (small-meshed) cod end. The fish retained in the cod ends of the two trawls of the twin-rigging thus either passed between the bars of the grid or entered the cod end via the large-mesh fish collection bag. As the two trawls had identical grids, collecting bags, and main cod-end configurations, it is reasonable to assume that any differences in bycatch composition and size distribution result from differences in the trawl belly configurations. To evaluate size selection resulting from the shortening of the trawl belly, we limited measurements to fish that could potentially have escaped through the meshes in the belly (below 30 cm total length). For Norway pout, the length measurements were restricted to a subsample of ~2 kg (~100 specimen), which were measured from each cod end, while the remaining catch was weighed. For the other small fish, all specimens were

identified to species, measured for length, and their total weight recorded.

The relative efficiency of the test trawl was estimated by applying a polynomial logistic regression (Holst and Revill 2009). The expected proportion (π) of specimens of length l in the test trawl relative to the combined catch in both trawls was modelled by fitting a k -order polynomial using a generalized linear mixed effect model (GLMM) with logistic link. When adding polynomial orders, model convergence gradually becomes more difficult to achieve. Standardizing carapace length within length classes helps:

$$(1) \quad l' = \frac{l - \bar{l}}{s}$$

where l' is the standardized CL of shrimp in length class l , \bar{l} is the mean, and s the standard deviation of CL of all the shrimp measured in each trial.

The k -order polynomial for haul j then becomes

$$(2) \quad \text{logit}[\pi_j(l'; \alpha, \beta)] \approx \log\left(\frac{q_{ij}}{q_{cj}}\right) + \alpha_0 \cdot \text{CPUE}_j + \alpha_1 \cdot \text{CPUE}_j \cdot l' + \beta_0 + b_{0j} + \beta_1 \cdot l' + b_{1j} \cdot l' + \dots + \beta_k (l')^k + b_{kj} (l')^k$$

Fig. 2. The conventional trawl of *Silje Kristina* used in trial 2.

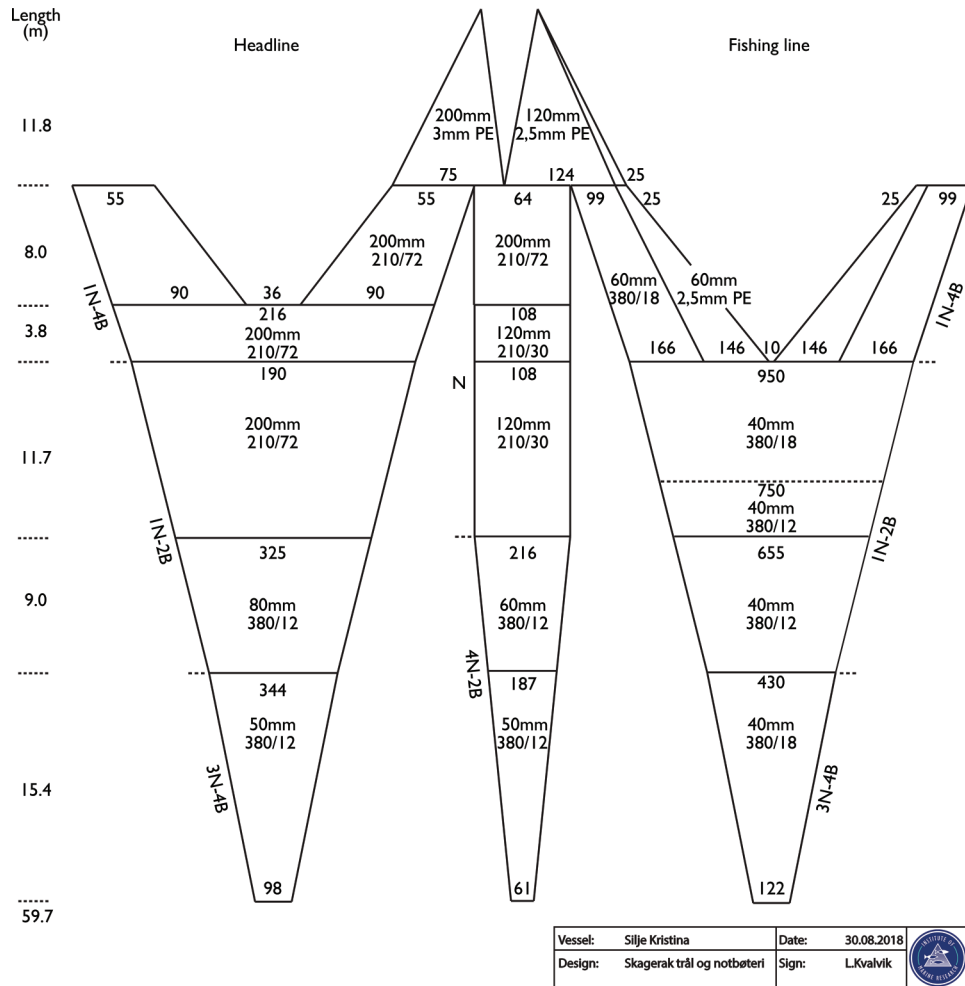

where π is the expected proportion of specimens in length interval l' in the test trawl relative to the combined catch in both trawls, $\log(q_{ij}/q_{cj})$ is an offset, with q_{ij} and q_{cj} denoting the sampling proportions from the test and the control catches, respectively. $CPUE_j$ is shrimp catch rate ($\text{kg}\cdot\text{h}^{-1}$) in the control trawl. $\alpha = (\alpha_0, \alpha_1)$ and $\beta = (\beta_0, \dots, \beta_k)$ are the parameters to be estimated. $\mathbf{b}_j = (b_{1j}, \dots, b_{kj})$ is the random effects vector for β . Each b_j is normally distributed $N(0, \sigma_j^2)$, with σ^2 accounting for the between-haul differences. In practice, we thus have a relative selection curve for each haul. A forward selection procedure was followed, increasing the k order by one at a time and selecting the model with the lowest Akaike information criterion (AIC), before all combinations of CPUE were tested. While model parameters are presented for standardized CL, the relative retention is shown on the scale of measurement, i.e., CL in millimetres. Length-dependent catch loss r_i with the shorter test trawl, given that both trawls catch the largest shrimp equally, is derived from the relative catch π_i :

$$(3) \quad r_i = 1 - \frac{\pi_i}{1 - \pi_i}$$

The GLMM analysis was performed for both shrimp and Norway pout. Standardized residuals were checked for normality and homogeneity. Models were then checked for over- or underdispersion. The lme4 package in R (Bates et al. 2015; R Core Team 2017) was used for the analysis.

Results

In trial 1, aboard *Tempo*, a total of 10 valid hauls were taken (one haul was excluded due to a torn net). Fishing depths ranged from 130 to 400 m, and the average tow duration was 9.3 h. Shrimp catches in individual hauls ranged from 210 to 673 kg per cod end (Table 1). In trial 2, on board *Silje Kristina*, 14 hauls were taken at depths from 150 to 270 m, with mean tow duration of 6.3 h. Shrimp from 13 of these hauls were measured, with catches ranging from 77 to 467 kg per cod end. In both trials towing speed was $\sim 0.8 \text{ m}\cdot\text{s}^{-1}$ (1.6 knots).

Fifth- and second-order polynomial models gave “best fit” for shrimp in trials 1 and 2, respectively (Table 2). The residual inspection did not reveal any signs of model mismatch, and the dispersion parameter was estimated at 1.00 and 0.98 for trials 1 and 2, respectively. The shorter trawls were more size-selective, with retention increasing with shrimp size. For both trials, the trawls fished about equally for shrimp above 19 mm CL, the joint curves flattening out just below 0.5 relative retention probabilities. At 15.5–16 mm CL, the short-belly trawl retained only half the number of shrimp retained by the standard trawl (Fig. 6; $\pi = 0.33$, catch loss = 0.5). The effect of CPUE was insignificant for both trials.

The fish catches in the *Silje Kristina* experiment (fish $< \sim 30$ cm) comprised cod (*Gadus morhua*, 7–28 cm, median = 17 cm), haddock (*Melanogrammus aeglefinus*, 7–28 cm, median = 9 cm), hake (*Merluccius merluccius*, 10–19 cm, median = 13.5 cm), Norway pout (*Trisopterus esmarkii*, 9–20 cm, median = 14 cm), silvery pout (*Gadiculus argenteus*,

Fig. 3. The shorter trawl of *Tempo* used in trial 1.

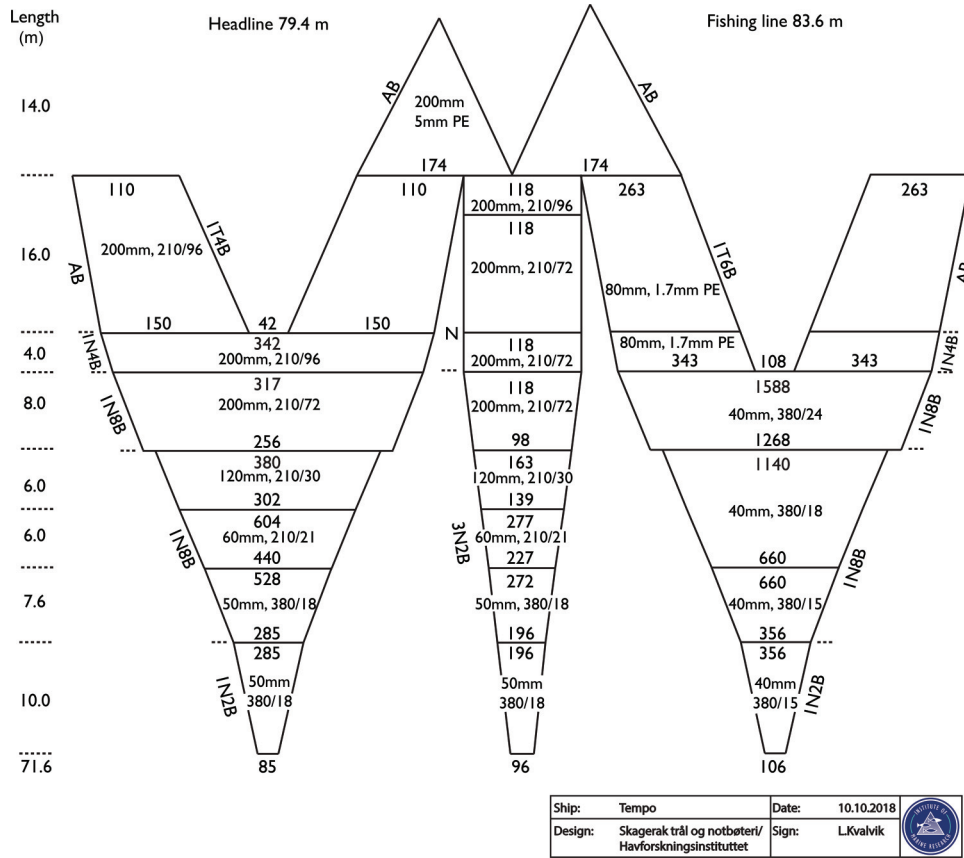

Fig. 4. The shorter trawl of *Silje Kristina* used in trial 2.

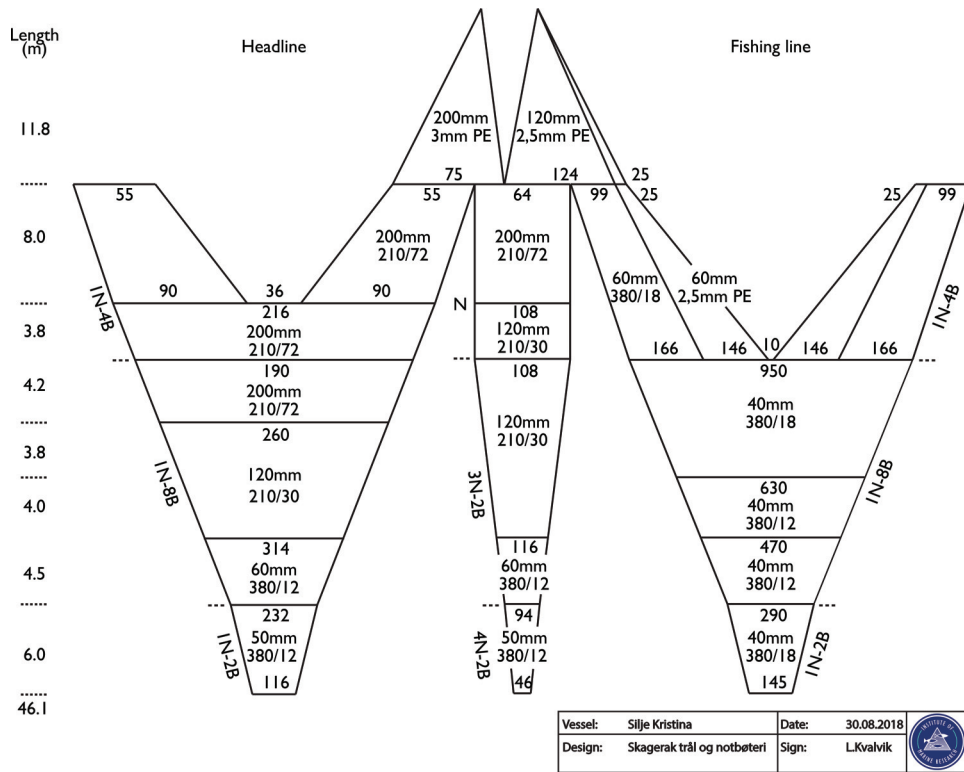

Fig. 5. A schematic drawing of the geometric differences between the standard and short-belly trawl used in the experiments on board the *Tempo*. Note the difference in the slope of the bottom panel of the bellies.

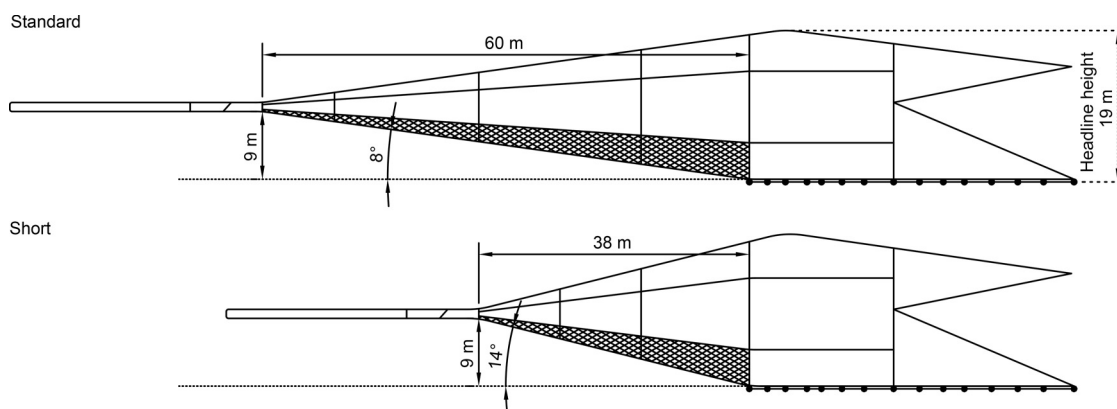

Table 1. Positions, setting time, tow duration, depth range, and shrimp catches for each haul.

Haul	Date (d/m/y)	Lat. (N)	Long. (E)	Duration (h:min)	Depth (m)	Test (kg)	Control (kg)
Tempo							
1	09/11/17	2137	58°38.93	9°30.19	07:23	233–363	210 286
2	10/11/17	0712	58°44.69	9°41.34	05:47	173–340	297 292
4	11/11/17	0001	58°45.43	9°42.93	09:13	275–394	288 330
5	11/11/17	1030	58°45.07	9°43.02	12:29	249–369	464 558
6	12/11/17	2327	58°39.18	9°38.42	10:55	215–395	485 499
7	13/11/17	1115	58°42.97	9°38.42	13:48	254–406	274 316
8	14/11/17	0315	58°47.09	10°05.72	08:36	160–233	471 441
9	14/11/17	1249	58°41.67	10°25.09	07:44	147–165	303 292
10	14/11/17	2110	58°32.73	10°33.13	10:46	131–161	673 574
11	15/11/17	0929	58°47.99	10°13.23	05:49	185–315	273 289
Silje Kristina							
1	25/06/18	0514	58°57.02	9°46.28	03:49	154–197	136 239
2	25/06/18	1200	58°57.83	9°46.61	04:00	151–196	161 221
3	27/06/18	0717	58°50.25	10°13.29	06:35	159–209	177 216
4	27/06/18	1605	58°50.12	10°09.78	07:13	158–208	178 217
5	28/06/18	0149	58°49.90	10°10.59	07:48	169–208	156 184
6	29/06/18	0603	58°58.03	9°46.61	07:51	151–206	152 320
7	29/06/18	1701	58°46.15	9°58.82	11:10	176–268	313 467
8	02/07/18	0713	58°51.67	9°48.34	04:35	152–203	119 173
9	03/07/18	0650	58°50.34	10°07.24	04:10	177–207	130 150
11	03/07/18	1213	58°51.80	10°17.89	04:10	181–207	77 90
12	04/07/18	0651	58°50.40	10°06.55	08:12	178–213	183 198
13	05/07/18	0730	58°49.24	10°03.21	08:05	184–212	199 258
14	06/07/18	0507	58°58.02	9°47.18	04:37	208–255	81 126

Note: Times are in local time (UTC + 1 h for the cruise aboard *Tempo* and UTC + 2 h (daylight saving time) for cruise aboard the *Silje Kristina*). Duration is in hours and minutes, and depth is in metres. *Tempo*'s experimental trawl was torn during haul 3, and the haul was therefore excluded from the analysis. *Silje Kristina*'s shrimp catch was not measured for haul 10, and the haul has been excluded from the analysis.

7–14 cm, median = 10 cm), Argentine (*Argentina sphyraena*, 10–18 cm, median = 14 cm), American plaice (*Hippoglossoides platessoides*, 8–30 cm, median = 13 cm), lemon sole (*Microstomus kitt*, 8–31 cm, median = 16 cm), witch flounder (*Glyptocephalus cynoglossus*, 16–31 cm), spurdog (*Squalus acanthias*, 21–28 cm, median = 25 cm), and velvet belly (*Etmopterus spinax*, 12–37 cm, median = 20 cm) (Table 3). Size ranges of the bycatch species were similar. Of the fish species with body shape and size ranges to pass through 40 mm mesh sizes, only Norway pout was sufficiently numerous to permit a statistical analysis of the relative catch in the two trawl designs to be made. Size-dependent selection of pout due to shortening of the trawl was insignificant ($\beta_1 = -0.022$, SE = 0.018, $p = 0.22$). The final model thus becomes $\text{logit}(\pi) = \beta_0 = -0.108$ (SE = 0.0385, $p < 0.01$), suggesting a 10%

Table 2. Results of fitting the polynomial generalized linear mixed effect model (GLMM) for shrimp (see eq. 2 for details).

Parameter	Estimate	SE	p
Tempo			
β_0	0.0338	0.161	0.58
β_1	0.110	0.136	0.42
β_2	-0.630	0.233	0.007
β_3	0.539	0.183	0.0033
β_4	0.0498	0.0952	0.60
β_5	-0.125	0.0524	0.017
σ_0	0.171		
σ_1	0.337		
σ_2	0.639		
σ_3	0.107		
σ_4	0.243		
Silje Kristina			
β_0	-0.135	0.0531	0.01
β_1	0.309	0.0438	<0.001
β_2	-0.384	0.102	<0.001
σ_0	0.150		
σ_1	0.0809		
σ_2	0.312		

Note: The parameter estimates refer to the model fitted using standardized carapace length.

reduction in the relative catch of Norway pout in the shorter trawl (Fig. 7).

Discussion

Shortening the belly section of a shrimp trawl significantly affected the trawl's overall size selectivity, resulting in reduced catches of smaller shrimp. The results were consistent across the two surveys, although the studies were conducted on different sizes of boats with different trawl sizes and in different seasons and geographical areas. Shrimp probably enter the trawl along the bottom panel, and the combination of increased panel inclination and more open meshes with the shorter trawl enhances the probability of mesh penetration and thus of size selection.

For both experiments the catches of large shrimp (assumed to be fully retained by the 40 mm mesh panels in the lower belly regions) were similar for the experimental and control trawls (Fig. 6). This indicates equal performance of the experimental and control trawls for both the *Tempo* and *Silje Kristina* experiments.

Initial trials with a short-bellied trawl used bottom panels of 80 mm mesh sizes in the foremost part of the belly, gradually

Fig. 6. Northern shrimp (*Pandalus borealis*). Upper panels: the *Tempo* trial. Left: overall size distribution of shrimp caught in the cod ends of the standard (regular) and shorter trawls. Right: estimated catch retention by length (π) (left axis) with the shorter trawl relative to the combined catch in both trawls. The right axis shows the relative catch loss $r = 1 - \pi / (1 - \pi)$ with the shorter trawl. The dashed line at $\pi = 0.5$ ($r = 0$) indicates equal catches in both trawls, while the dashed line at $\pi = 0.33$ ($r = 0.5$) indicates 50% loss with the shorter trawl (crosses the curve at 15.7 mm carapace length). The shaded band is the 95% confidence region of the estimated relative retention curve. The open circles show pooled proportions caught in the shorter trawl. Lower panels: the *Silje Kristina* trial. Left: overall size distribution of shrimp caught in the cod ends of the standard and shorter trawls. Right: estimated catch retention by length (π) with the shorter trawl relative to the combined catch in both trawls (see above for detailed explanation).

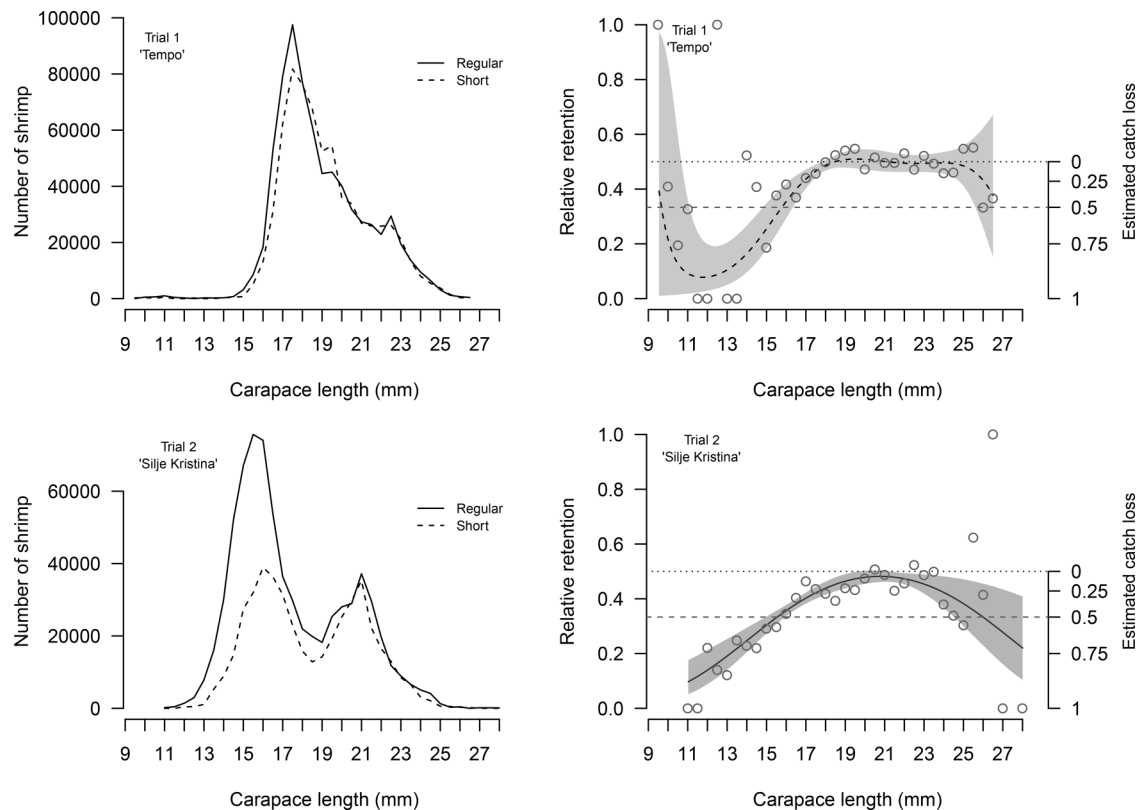

decreasing to 40 mm in the aft part, the same as used in *Tempo*'s regular trawls. We then observed catch losses of 27% of large shrimp (range 17% to 42%) and 54% of small shrimp (range 25% to 75%) with the shorter trawl (the shrimp were graded into two size categories with a mechanical grader, adjusted ad hoc by the fishers to separate at ~ 19 mm CL). The nominal mesh sizes in both bottom panels of the short-bellied trawl were therefore reduced to 40 mm. The catches of large shrimp then became 8% higher in the shorter trawl compared with the standard trawl with its longer belly and larger mesh sizes in the bottom panel (eight hauls, range -4% to 37%). The initial trials thus indicated that shrimp also escape through the bottom panels of the less steep-cut commercial trawl designs and that most shrimp pass along the bottom panel as they enter the trawl. For this reason, we used bottom panels of 40 mm mesh size in both the standard and short-bellied trawls during the experiments. Although the differences in catches of shrimp above 19 mm CL were insignificant between the two trawl designs (Fig. 6), the retention curve is slightly below the 0.5 relative catch rate. Polet (2000) found that the lateral part of the aft belly contributed most to the overall selectivity for brown shrimp (*Crangon crangon*). Shrimp were also observed escaping through side panels in the Icelandic shrimp trawl fisheries (Thorsteinsson 1981). This raises the question of whether a small proportion of the shrimp in our study might have passed through the side panels, where mesh sizes were larger (Figs. 1–4). Nevertheless, the study clearly shows that most selection in the belly region takes place in the bottom panel.

Our findings that trawl design affects size selectivity can be utilized to influence the size composition of shrimp catches to reduce catches of undersized shrimp. Our initial trials with larger meshes in the bottom panels suggest that the effects could be further enhanced by altering the mesh sizes of the bottom panel. In general, higher prices are paid for larger shrimp, improving the value of a given catch quota to the fisher. In addition, in areas and times with high proportions of undersized shrimp, size-selective fishing gear is important for fishers as a means of avoiding real-time closures of fishing areas. However, the overarching aim of the study, to which the short-bellied trawl contributes, is to maintain long-term sustainability by reducing catches of juvenile shrimp.

Alternative solutions for size selection of shrimp include modified cod-end configuration and rigid sorting grids. In Norwegian waters, only cod-end mesh sizes are regulated. Size selection using diamond-mesh cod ends is highly influenced by cod-end circumference (Ó.A. Ingólfsson and T. Jørgensen, Institute of Marine Research, Bergen, Norway, manuscript in preparation, 2019), and as the only regulated factor, mesh size is insufficient for minimizing catches of undersized shrimp. Square-mesh configurations reduced retention for juvenile northern shrimp (Thorsteinsson 1992), nylon shrimp (*Heterocarpus reedi*; Queirolo et al. 2012), eastern king prawns (*Panaeus plebejus*; Broadhurst et al. 2006) and some juvenile fish species (Thorsteinsson 1992; Broadhurst et al. 2006). Rigid grids for size selection (Valdemarsen et al. 1993; He and Balzano 2007, 2012) have also been tested. However, while their

Table 3. Bycatch by haul in the regular (Reg.) and short-belly trawl (Short) for the *Silje Kristina* fishing experiment (fish < ~30 cm).

Haul	Cod		Haddock		Hake		Silvery pout		Argentines		Spurdog		Velvet belly		American plaice		Lemon sole		Witch flounder		Norway pout	
	Reg.	Short	Reg.	Short	Reg.	Short	Reg.	Short	Reg.	Short	Reg.	Short	Reg.	Short	Reg.	Short	Reg.	Short	Reg.	Short	Reg.	Short
1							1	1	1				2	1	15	16			10	9	20.0	13.3
2			1						1		1	1	1	1	27	12		1	13	12	11.9	10.4
3			2				3		1				3	2	34	35		1	10	9	39.7	37.7
4	2		1				5				1		1	3	46	36		1	1	1	11.0	12.0
5			3				1	1					1	1	38	50			9	11	16.6	16.9
6	1		1				1	4	2		1		1	3	32	42		1	10	14	19.3	18.8
7			3				6						8	4	23	25		2	14	17	49.8	50.7
8			1				2		1		1	5	3	2	10	7		1	3	4	23.9	19.6
9	1						2		2				1	1	2	6		1	9	10	46.8	36.3
10	2						1				2		1	1	10	16			3	3	1.9	2.3
11			3				2		1		3		1	1	12	10		1	1	1	5.3	4.0
12			1				4	2					2	5	42	23		1	7	2	8.9	8.1
13			2				1		1			1	6	2	59	50		1	8	9	18.6	14.0
14			1				4	2	1	2		2	2	2	5	3		1	5	8	40.7	38.0
Total	4	4	10	10	10	10	27	13	7	6	5	10	32	26	355	331	6	7	103	106	314.4	282.1

Note: Catches are in number of individuals, except for Norway pout for which the catch in weight (kg) is reported. The species are reported in the table by their common names (cod (*Gadus morhua*), haddock (*Melanogrammus aeglefinus*), hake (*Merluccius merluccius*), silvery pout (*Gadiculus argenteus*), Argentines (*Argentina spp.*), spurdog (*Squalus acanthias*), velvet belly (*Etmopterus spinax*), American plaice (*Hippoglossoides platessoides*), lemon sole (*Microstomus kitt*), witch flounder (*Glyptocephalus cynoglossus*), and Norway pout (*Trisopterus esmarkii*)).

Fig. 7. Norway pout (*Trisopterus esmarkii*). Upper panel: estimated catch retention (π) by length with the shorter trawl, relative to the combined catch in both trawls for the *Silje Kristina* experiment (trial 2). The solid line at $\pi = 0.5$ indicates equal catches in both trawls, and the shaded band is the 95% confidence region of the estimated relative retention. Lower panel: size distribution of specimens caught in the cod ends of the standard (regular) and shorter trawls.

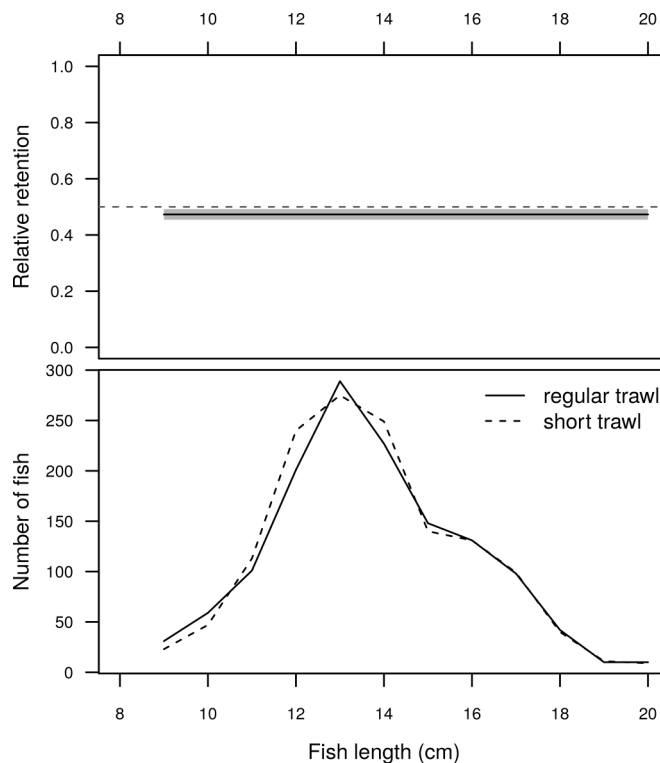

complementary size selection is valuable, the principle of parsimony advises adoption of the simplest solution. Therefore, the fundamental components of a trawl should be improved in line with management objectives before rigid devices are enforced by legislation. A trawl designed for size selection should thus be used for selecting early in the capture process, although that solution would not rule out the use of other selection devices. Since a cod end is an essential component of a trawl, it should also be designed, in line with available knowledge, for complementary selection.

With the exception of Norway pout, bycatch levels were generally low in *Silje Kristina* experiments. Pout catches were slightly lower (10%) in the shorter trawl, independent of length. This indicates that the 40 mm meshes of the bottom panels are too small for pout in the size range encountered during the experiment (10–20 cm) to escape. However, some fish are likely distributed farther off the bottom and encounter the side or top panels of the trawl belly. The meshes here are larger (200, 120, and 60 mm mesh size (front to aft); Figs. 1–4) and permit the escape across the entire length range of the pout caught. The increased panel inclination and more open meshes with the shorter trawl presumably result in higher overall escape rate as compared with the standard trawl. For the other species, only silvery pout was of body shape and size to be considered a candidate for mesh selection using 40 mm meshes. The overall catches of silvery pout (median length 10 cm) were about halved in the shorter trawl, although only 40 specimens were caught. Modified trawl designs in panaeid shrimp trawl fisheries were compared by Broadhurst et al. (2012). Shorter trawls yielded significantly reduced bycatch of southern herring (*Herklotsichthys castelnaui*), demonstrating the potential for bycatch reduction by altering trawl design. Bycatch of juvenile fish is a

problem in some Northern shrimp fisheries (Gullestad et al. 2015). Reduced trawl length could potentially help to mitigate this, but presumably only for juveniles below sizes of ~10 cm, e.g., 0-group gadoids.

Broadhurst et al. (2012, 2014) also demonstrated significantly reduced drag by shortening the trawls and thereby reducing the twine area that produces tow resistance. The incentives and potential for improving trawl design in the shrimp fisheries are therefore quite substantial.

With a shorter trawl belly, the shrimp will hit the panel at a greater angle, improving their chances of escaping through meshes with greater side openings. Steeper inclination angle and increased mesh opening result from steeper cutting rates. However, shrimp trawls differ in both size and shape. One of the main differences is the number of netting panels used to produce the trawl belly, usually either two or four. Some adaptation of the concept to the many designs in current use is thus to be expected.

The trials showed no detectable effect of catch rates on size selection efficiency of the short trawl. The catch rates observed in the short trawl during the experiments (range 19.9–62.5 kg·h⁻¹ for the *Tempo* and 17.5–40.3 kg·h⁻¹ for the *Silje Kristina*) were within the range normally observed during commercial fishing (recent mean and maximum catch rates of 20–30 and 50 kg·h⁻¹ per trawl, respectively, and a 3-year maximum of 120 kg·h⁻¹ per trawl; F. Jensen, skipper of the *Tempo*, personal communication). The large area of the selective bottom panels is probably large enough to maintain their efficiency even at high densities of shrimp. In comparison with size-selective grids that tend to clog in challenging situations (Ó. Ingólfsson, personal observation), amending the trawl design is a more favourable choice.

The trawls used in the trials came from the trawl supplier with the biggest market share in the Skagerrak area. The change in trawl design from conventional to shorter belly length should therefore be easy to replicate for most of the fleet. It is reasonable to assume that the improvement in selectivity obtained by shortening the trawl belly will be consistent across trawl designs, as most of the shrimp trawls in the area are of similar layout, i.e., four-panel designs. However, these do vary and seem to some extent to be area-specific. In the coastal fisheries in northern Norway, for instance, a two-panel design is preferred by most fishers. In line with our discussion of various trawl designs and variances in juvenile shrimp prevalence, we suggest that further research should explore the effects of various cutting rates on different trawl sizes and designs at different times of the year and in different areas. The potential of reducing juvenile fish catches by altering trawl design should also be explored, and potential changes in towing resistance should be evaluated. However, future efforts should not focus solely on the technical aspects but also improve our understanding of shrimp behaviour, including temporal variations in their vertical distribution and responses to the approaching net.

Acknowledgements

The authors thank the editor and two anonymous reviewers for their comments on a previous version of the manuscript. We are also grateful to Hugh Allen for language editing and valuable comments. We thank our co-workers Liz Kvalvik and Inger Henriksen, skipper Frode Jensen on F/V *Tempo* and skipper Trond Erikssen on F/V *Silje Kristina* and their crews, and Peder Asbjørn Pedersen at the Skagerak trål og notbøteri AS net-loft for invaluable assistance during all stages of this study. Henning Wehde, head of Institute of Marine Research's research and advice program for the North Sea and Skagerrak, is thanked for support and encouragement. This study was co-financed by FHF (The Norwegian Seafood Research Fund) project No. 901303.

References

- Aldrin, M., Mortensen, B., Størvik, G., Nedreaas, K., Aglen, A., and Aanes, S. 2012. Improving management decisions by predicting fish bycatch in the Barents Sea shrimp fishery. *ICES J. Mar. Sci.* **69**(1): 64–74. doi:10.1093/icesjms/fsr172.
- Anonymous. 2005. Regulations on exercising sea-water fisheries. [Forskrift om utøvelse av fiske i sjøen.] [online] Available from <https://lovdata.no/dokument/SF/forskrift/2004-12-22-1878>. [In Norwegian.]
- Bates, D., Maechler, M., Bolker, B., and Walker, S. 2015. Fitting linear mixed-effects models using lme4. *J. Stat. Softw.* **67**(1): 1–48. doi:10.18637/jss.v067.i01.
- Broadhurst, M.K., Millar, R.B., Wooden, M.E.L., and Macbeth, W.G. 2006. Optimising codend configuration in a multispecies demersal trawl fishery. *Fish. Manage. Ecol.* **13**(2): 81–92. doi:10.1111/j.1365-2400.2006.00479.x.
- Broadhurst, M.K., Sterling, D.J., and Millar, R.B. 2012. Short vs long penaeid trawls: Effects of side taper on engineering and catching performances. *Fish. Res.* **134–136**: 73–81. doi:10.1016/j.fishres.2012.08.009.
- Broadhurst, M.K., Sterling, D.J., and Millar, R.B. 2014. Configuring the mesh size, side taper and wing depth of penaeid trawls to reduce environmental impacts. *PLoS ONE*, **9**(6): e99434. doi:10.1371/journal.pone.0099434. PMID: 24911786.
- Christensen, S., and Lassen, H. 1990. Selection in shrimp trawl. NAFO SCR Doc. 90/56 [online]. Available from <https://www.nafo.int/Portals/0/PDFs/sc/1990/scr-90-056.pdf> [accessed 23 January 2019].
- Degel, H., Lassen, H., and Lehmann, K. 1991. Selectivity in shrimp trawl. NAFO SCR Doc. 91/41 [online]. Available from <https://www.nafo.int/Portals/0/PDFs/sc/1991/SCR-91-041.PDF?ver=2016-02-22-154121-750> [accessed 23 January 2019].
- Eigaard, O.R., and Munch-Petersen, S. 2011. Influence of fleet renewal and trawl development on landings per unit effort of the Danish northern shrimp (*Pandalus borealis*) fishery. *ICES J. Mar. Sci.* **68**(1): 26–31. doi:10.1093/icesjms/fsq141.
- Garcia, E.G. 2007. The Northern Shrimp (*Pandalus borealis*) offshore fishery in the Northeast Atlantic. *Adv. Mar. Biol.* **52**: 147–266. doi:10.1016/S0065-2881(06)52002-4. PMID:17298891.
- Graham, K.J., Broadhurst, M.K., and Millar, R.B. 2009. Effects of codend circumference and twine diameter on selection in south-eastern Australian fish trawls. *Fish. Res.* **95**: 341–349. doi:10.1016/j.fishres.2008.10.001.
- Gullestad, P., Blom, G., Bakke, G., and Bogstad, B. 2015. The “Discard Ban Package”: Experiences in efforts to improve the exploitation patterns in Norwegian fisheries. *Mar. Pol.* **54**: 1–9. doi:10.1016/j.marpol.2014.09.025.
- Halliday, R.G., and Cooper, C.G. 1999. Evaluation of separator grates for reduction of bycatch in the silver hake (*Merluccius bilinearis*) otter trawl fishery off Nova Scotia, Canada. *Fish. Res.* **40**(3): 237–249. doi:10.1016/S0165-7836(98)00229-X.
- He, P., and Balzano, V. 2007. Reducing the catch of small shrimps in the Gulf of Maine pink shrimp fishery with a size-sorting grid device. *ICES J. Mar. Sci.* **64**(8): 1551–1557. doi:10.1093/icesjms/fsm098.
- He, P., and Balzano, V. 2012. Improving size selectivity of shrimp trawls in the Gulf of Maine with a modified dual-grid size-sorting System. *North Am. J. Fish. Manag.* **32**(6): 1113–1122. doi:10.1080/02755947.2012.720642.
- Hickey, W.M., Brothers, G., and Boulos, D.L. 1993. By-catch reduction in the northern shrimp fishery. *Can. Tech. Rep. Fish. Aquat. Sci.* No. 1964. Fisheries and Oceans Canada, St. John's, Newfoundland and Labrador.
- Hillis, J.P., and Earley, J.J. 1982. Selectivity in the *Nephrops* trawl. *ICES CM* 1982/B:19.
- Holst, R., and Revill, A. 2009. A simple statistical method for catch comparison studies. *Fish. Res.* **95**: 254–259. doi:10.1016/j.fishres.2008.09.027.
- Isaksen, B., Valdemarsen, J.W., Larsen, R.B., and Karlsen, L. 1992. Reduction of fish bycatch in shrimp trawl using a rigid separator grid in the aft belly. *Fish. Res.* **13**(3): 335–352. doi:10.1016/0165-7836(92)90086-9.
- Kelleher, K. 2005. Discards in the world's marine fisheries. An update. FAO Fisheries Technical Paper No. 470. Rome, FAO. 2004.
- Lehmann, K., Valdemarsen, J.W., and Riget, F. 1993. Selectivity in shrimp trawl codends tested in a fishery in Greenland. *ICES Mar. Sci. Symp.* **196**: 80–85.
- Madsen, N., and Hansen, K.E. 2001. Danish experiments with a grid system tested in the North Sea shrimp fishery. *Fish. Res.* **52**: 203–216. doi:10.1016/S0165-7836(00)00234-4.
- Polet, H. 2000. Codend and whole trawl selectivity of a shrimp beam trawl used in the North Sea. *Fish. Res.* **48**(2): 167–183. doi:10.1016/S0165-7836(00)00125-9.
- Queirolo, D., Hurtado, C.F., Ahumada, M., Gaete, E., Soriguer, M.C., and Erzini, K. 2012. Alternative codends to improve the size selectivity for nylon shrimp (*Heterocarpus reedi*) and yellow squat lobster (*Cervimunida johni*) off the Chilean coast. *J. Appl. Ichthyol.* **28**: 537–544. doi:10.1111/j.1439-0426.2012.01949.x.
- R Core Team. 2017. R: a language and environment for statistical computing [online]. R Foundation for Statistical Computing, Vienna, Austria. Available from <https://www.R-project.org/>.
- Reeves, S.A., Armstrong, D.W., Fryer, R.J., and Coull, K.A. 1992. The effects of mesh size, cod-end extension length and cod-end diameter on the selectivity of Scottish trawls and seines. *ICES J. Mar. Sci.* **49**: 279–288. doi:10.1093/icesjms/49.3.279.
- Sala, A., and Lucchetti, A. 2011. Effect of mesh size and codend circumference on selectivity in the Mediterranean demersal trawl fisheries. *Fish. Res.* **110**: 252–258. doi:10.1016/j.fishres.2011.04.012.

- Thomassen, T., and Ulltang, Ø. 1975. Report from mesh selection experiments on *Pandalus borealis* in Norwegian waters. ICES CM 1975/K:51.
- Thorsteinsson, G. 1981. The effect of net slack in the sidepanels of shrimp trawls on the size distribution of the catch. ICES CM 1981/B:5.
- Thorsteinsson, G. 1992. The use of square mesh codends in the Icelandic shrimp (*Pandalus borealis*) fishery. Fish. Res. 13(3): 255–266. doi:10.1016/0165-7836(92)90080-D.
- Valdemarsen, J.W., and Mikalsen, L. 1991. Preliminary tests with a grid arrangement to select sizes of shrimp in trawls. ICES Fishing Technology and Fish Behavior Working Group Meeting, Ancona, 22–24 April 1991.
- Valdemarsen, J.W., Lehmann, K., Riget, F., and Boje, J. 1993. Grid devices to select shrimp size in trawls. ICES C.M. 1993/B:35, Ref. K.
- Wileman, D., Ferro, R.S.T., Fonteyne, R., and Millar, R.B. (Editors). 1996. Manual of methods of measuring the selectivity of towed fishing gears. ICES Cooperative Research Report No. 215.